

**Makita**

**PARTI DI RICAMBIO**

**Modello M445x 230V~**

**Cod. 99611BEB**

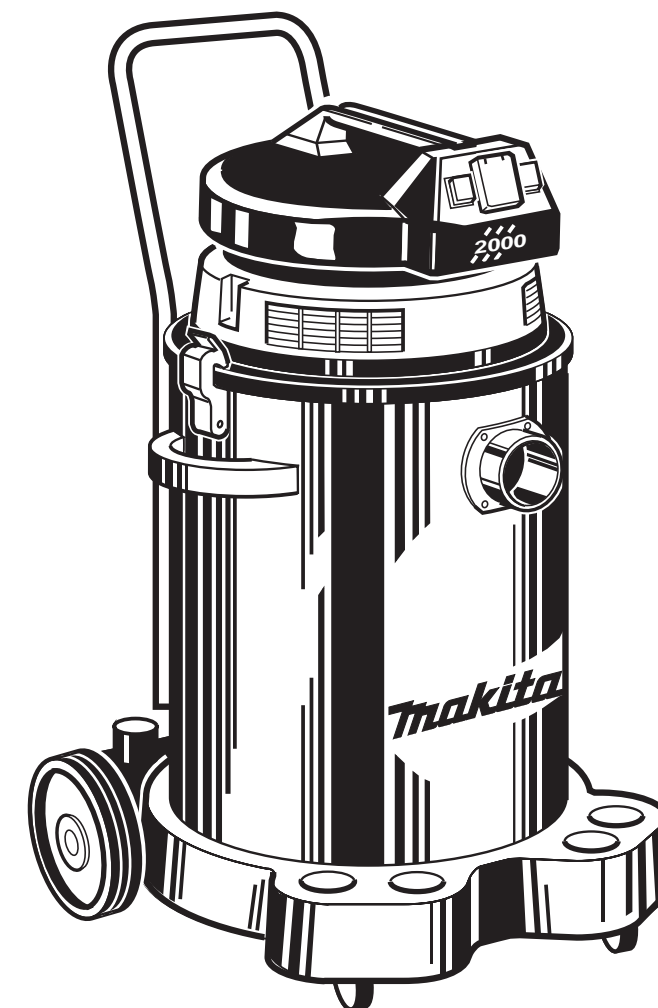

**Makita**

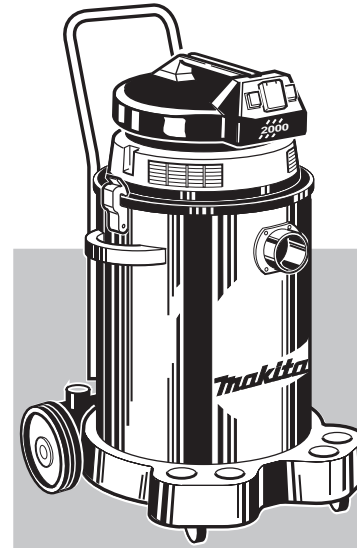
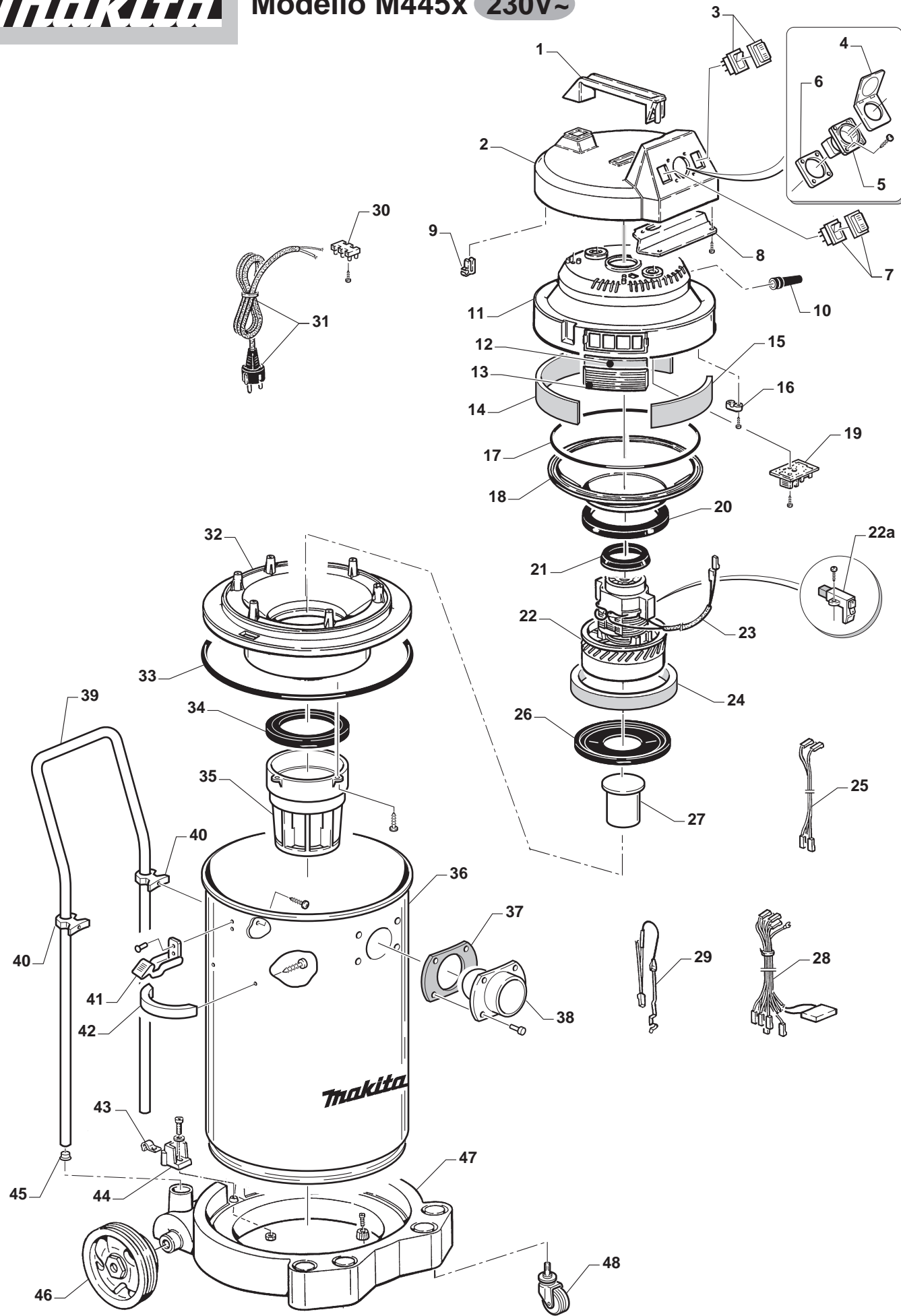



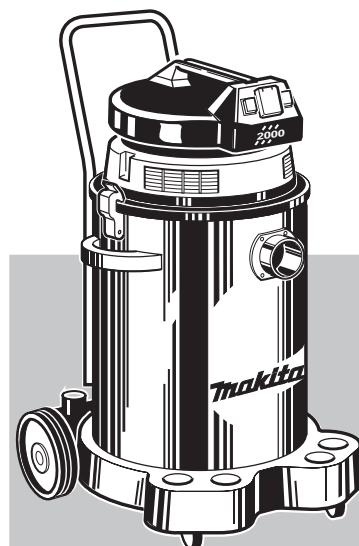
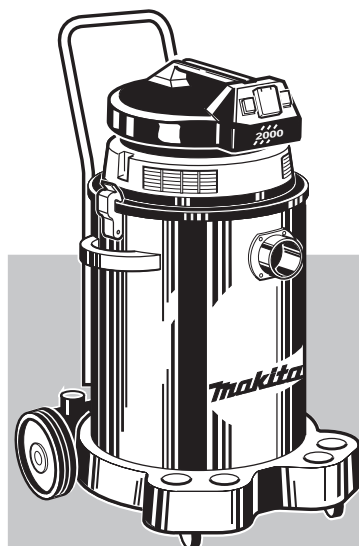



Blank lined area for notes or additional information.

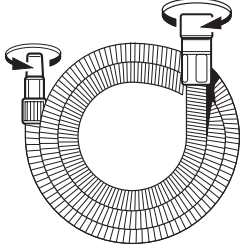
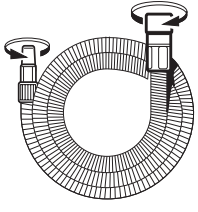
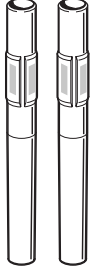

**Modello M445x 230V~**

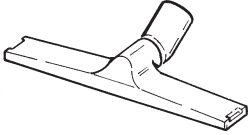
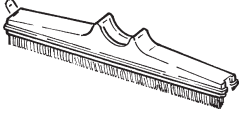
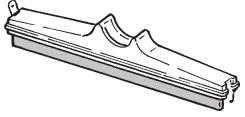
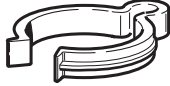
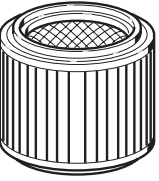
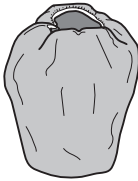
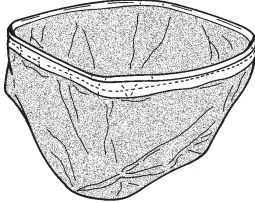
Pos.	Descrizione	Codice	Prezzo € (Cad)
01	Impugnatura .....	50310B8B .....	
02	Calotta .....	50305B8B .....	
03	Interruttore bipolare nero .....	80041BDN .....	
04	Cornice + coperchio .....	80202B8N .....	
05	Presa Schuko .....	80200B8N .....	
06	Ghiera per presa .....	50315BDV .....	
07	Interruttore unipolare .....	80042BDN .....	
08	Piastra di chiusura .....	50300BDV .....	
09	Forcella fermacavo .....	50335BEN .....	
10	Guidacavo .....	50338BEN .....	
11	Coprimotore .....	50181B0A .....	
12	Filtro alla griglia .....	83021B8X .....	
13	Griglia uscita aria .....	50170B8A .....	
14	Silenziatore lungo alla calotta .....	83022B8X .....	
15	Silenziatore corto alla calotta .....	83023B8X .....	
16	Fermacavo .....	50333BEN .....	
17	Guarnizione tonda .....	70016B8N .....	
18	Diaframma .....	50104B9V .....	
19	Scheda elettronica integrata .....	80209BDX .....	
20	Guarnizione tenuta motore .....	70057B0N .....	
21	Ammortizzatore superiore motore .....	70062B0N .....	
22	Motore by-pass 1200W .....	20051B0X .....	
22a	Inserto porta spazzole completo per motore ED .....	80050B0X .....	
23	Tubetto PVC nero mm. 110 - ø 6 mm. ....	60235BHN .....	
24	Anello silenziatore .....	83020B8X .....	
25	Cavetti verde/giallo l= 360 mm .....	80099BEV .....	
26	Ammortizzatore supporto motore .....	70046B5N .....	
27	Galleggiante .....	50077B0V .....	
28	Serie cavetti .....	80102BEV .....	
29	Lamella correnti elettrostatiche .....	30076B5X .....	
30	Morsetto tripolare .....	80029B0I .....	
31	Cavo di alimentazione .....	80017B0N .....	
32	Supporto motore .....	50064BEB .....	
33	Tondino gommaspugna ø 5 mm. ....	70016B0N .....	
34	Cuscinetto in gomma .....	70045B5N .....	
35	Cestello portacartuccia .....	50102B5N .....	
36	Contenitore .....	10002B0X .....	
37	Guarnizione .....	70082B5X .....	
38	Raccordo entrata aria .....	50079BEB .....	
39	Impugnatura a forcella .....	40024B5X .....	
40	Ritegno per asta cromata .....	01900BEB .....	
41	Cerniera completa .....	01016BEB .....	
42	Impugnatura contenitore .....	50116BEB .....	
43	Molla per ritegno .....	30064B5X .....	
44	Ritegno di fissaggio .....	50101BEB .....	
45	Tappo per impugnatura a forcella .....	50375B5N .....	
46	Ruota posteriore .....	60057B5N .....	
47	Carrello .....	50124BEB .....	
48	Ruota anteriore .....	30083B5X .....	

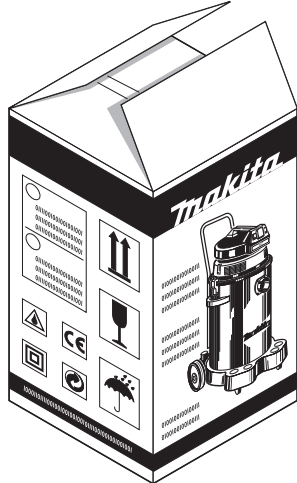
 A1	 A2	 A3	 A4
 A5	 A6	 A7	 A8
 A9	 A10	 A11	
 A12	 A13	 A14	
 A15	 A16		

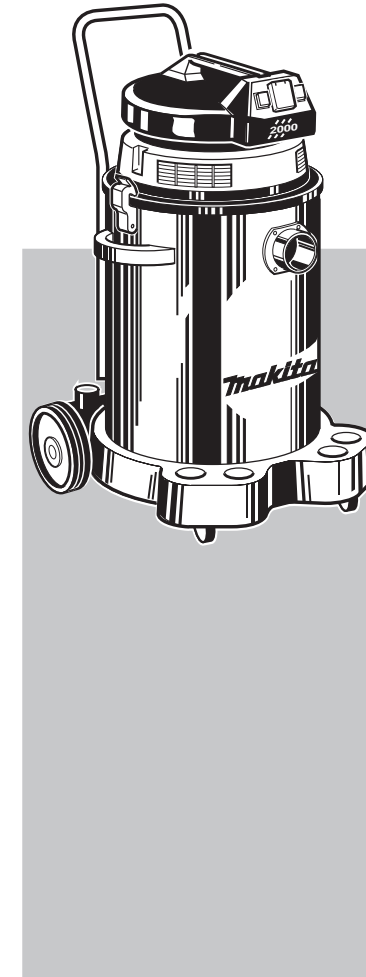

Pos.	Descrizione	Codice	Prezzo € (Cad)
A01	Tubo flessibile ø 45 - L=mt. 2 completo di manicotti .....	01316B0N .....	
A02	Tubo flessibile per elettroutensile ø 25 - L= mt. 3 completo di manicotti .....	01321B0N .....	
A03	Prolunga rigida ø 45 .....	50091B0N .....	
A04	Impugnatura ergonomica ø 45 .....	50093B0N .....	
A05	Anello deflussore .....	50095B0N .....	
A06	Bocchetta a lancia ø 45 .....	50080B0N .....	
A07	Bocchetta triangolare ø 45 .....	50089B0N .....	
A08	Spazzola multiuso ø 45 .....	60277B0N .....	
A09	Inserto polvere .....	60279B0N .....	
A10	Racla per raccoglieliquidi .....	60278B0N .....	
A11	Ghiera blocca cavo per A.S.S. ....	50318BHN .....	
A12	Cartuccia filtro "BIA" (conf. 6 pz.) .....	83200BEB .....	
A13	Filtro-mousse .....	83035BHB .....	
A14	Sacco filtro P.P. 380x390 H .....	83038B5A .....	
A15	Confezione sacco in carta filtro verticale BIA "C" (5 Pz.) .....	83132BEK .....	
A16	Imballo in cartone M445x .....	87010BEH .....	

**Schema elettrico**

**Legenda colore cavi / Cable colour coding**

W	Bianco / White
Bk	Nero / Black
R	Rosso / Red
Br	Marrone / Brown
Bl	Blu / Blue
Gr	Verde / Green
Y	Giallo / Yellow

\* - con faston - with faston

